



Challenges Faced by Electric Vehicle Motors Drives and Their Solutions

Presented By
Dr. Rajesh M. Pindoriya
Member, IEEE
Project Engineer, IIT Mandi
rajeshpindoriya@ieee.org

Speaker Biodata

Dr. Rajesh M. Pindoriya (GM'14 - M'20) received the B. Tech degree in Electrical and Electronics Engineering from Rajasthan Technical University Kota, Rajasthan, India in 2012 and M. E. in Power Electronics and Electrical Drives from Gujarat Technological University, Ahmedabad, Gujarat, India in 2014. He received Ph.D. degree in Power Electronics and Electrical Drives from the Indian Institute of Technology Mandi, India, in 2020. He is currently working as a Project Engineer at IIT Mandi, India.

His research interests include design controllers for the Permanent Magnet Synchronous Motor (PMSM) and Brushless Direct Current (BLDC) motor drives. Also, working on analysis and reduction of acoustic noise and vibration of PMSM and BLDC Motor drives. Dr. Pindoriya is a member of the Institution of Electronics and Telecommunication Engineers (IETE) (AM'17, M'21) and member of the Institution of Engineering (IE) (AM'17, M'21).



Outlines

Introduction to Electric Vehicles (EVs) and Hybrid Electric Vehicles (HEVs)

Schematic Layout of EVs and HEVs

Major Components of EVs and HEVs

Major Challenges of EVs and HEVs

Solutions of Challenges

What is an Electric Drives

Definition of electric drive

- ❖ “Systems employed for motion control are called **drives**”
- ❖ “Drives employing electric motors are known as **electrical drives**”

Why its required

- ❖ To control the speed and torque of the electric motors

Applications of electric drives



Electric Vehicles



Celling fan



Refrigerator



Lift



Vacuumed cleaner



Ship

Introduction: Electric Drives

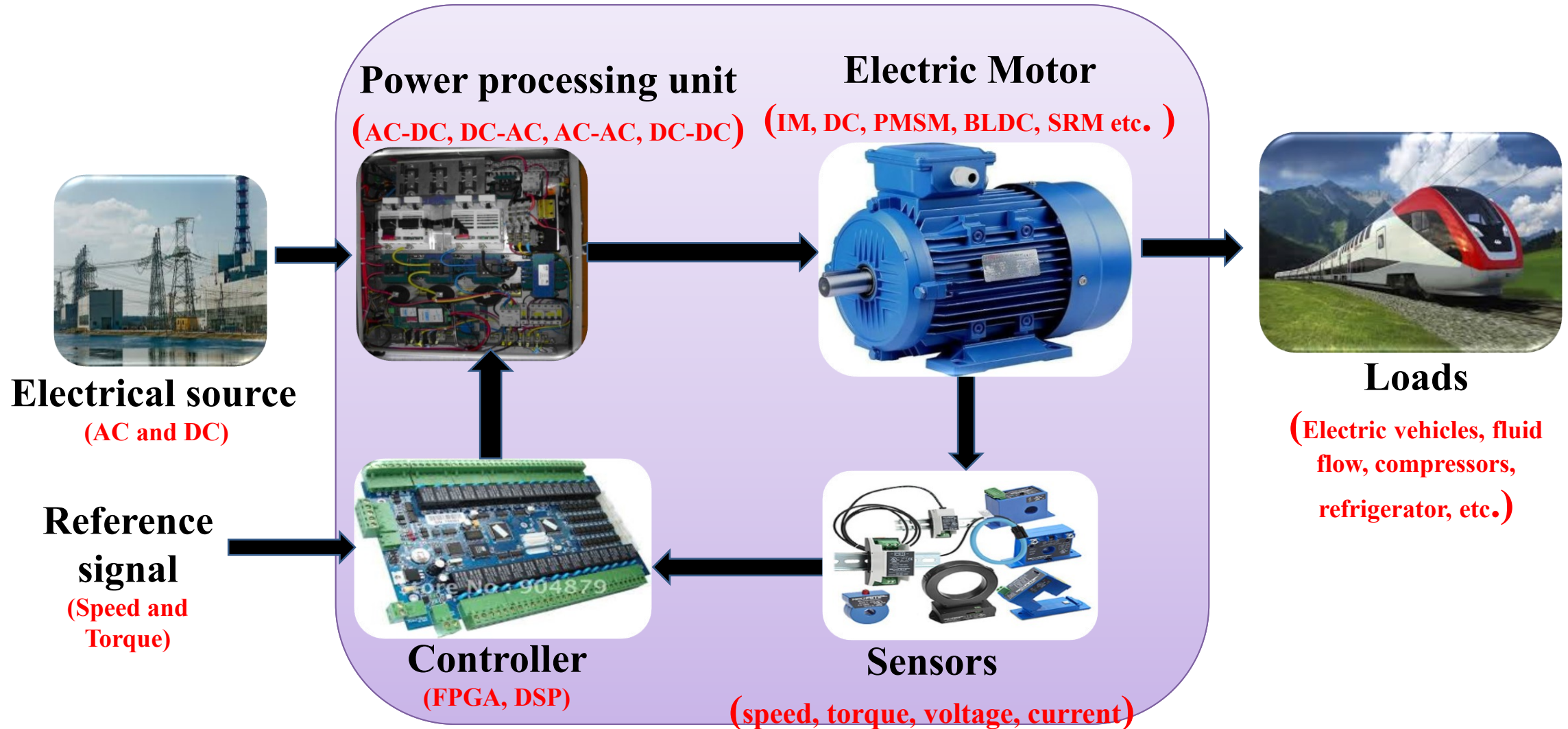

Introduction to Electric Vehicles

- An **Electric Vehicles (EVs)**, uses one or more electric motors or traction motors for propulsion.
- An EVs may be powered through a collector system by *electricity from off-vehicle sources, or may be self-contained with a battery, solar panels or a generator to convert fuel to electricity*



- A **Hybrid Electric Vehicles (HEVs)** combines any two power (energy) sources.
- Possible combinations include *diesel/electric, gasoline/fly wheel, and fuel cell (FC)/battery.*
- Typically, one energy source is storage, and the other is conversion of a fuel to energy.

The Benefits of Driving Electric Vehicles

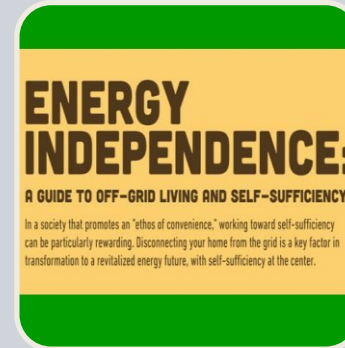

Save you
more than
70% on
fuel costs

No
emissions

Reduce the
dependence
on foreign
oil

Have higher
satisfaction
levels

Comparisons Between Conventional and Electric Vehicles [1]

	Petrol (ICE)	Hybrid (HEV)	Plugin Hybrid (PHEV)	100% Battery (EV, REEV, BEV)
Range	440 miles	440 miles	440 miles	100 miles
Refuel Time	5min	5min	<1h	4 – 8h
Usage	1st Family car	1st Family car	1st Family car	2nd City car
Energy Efficiency	Not Efficient	Efficient	More Efficient	Most Efficient

PHEV: Plug-In Hybrid Electric Vehicle, REEV: Range Extended Electric Vehicle
 BEV: Battery Electric Vehicle, EV: Electric Vehicle

Configuration of Electric Vehicles [2]

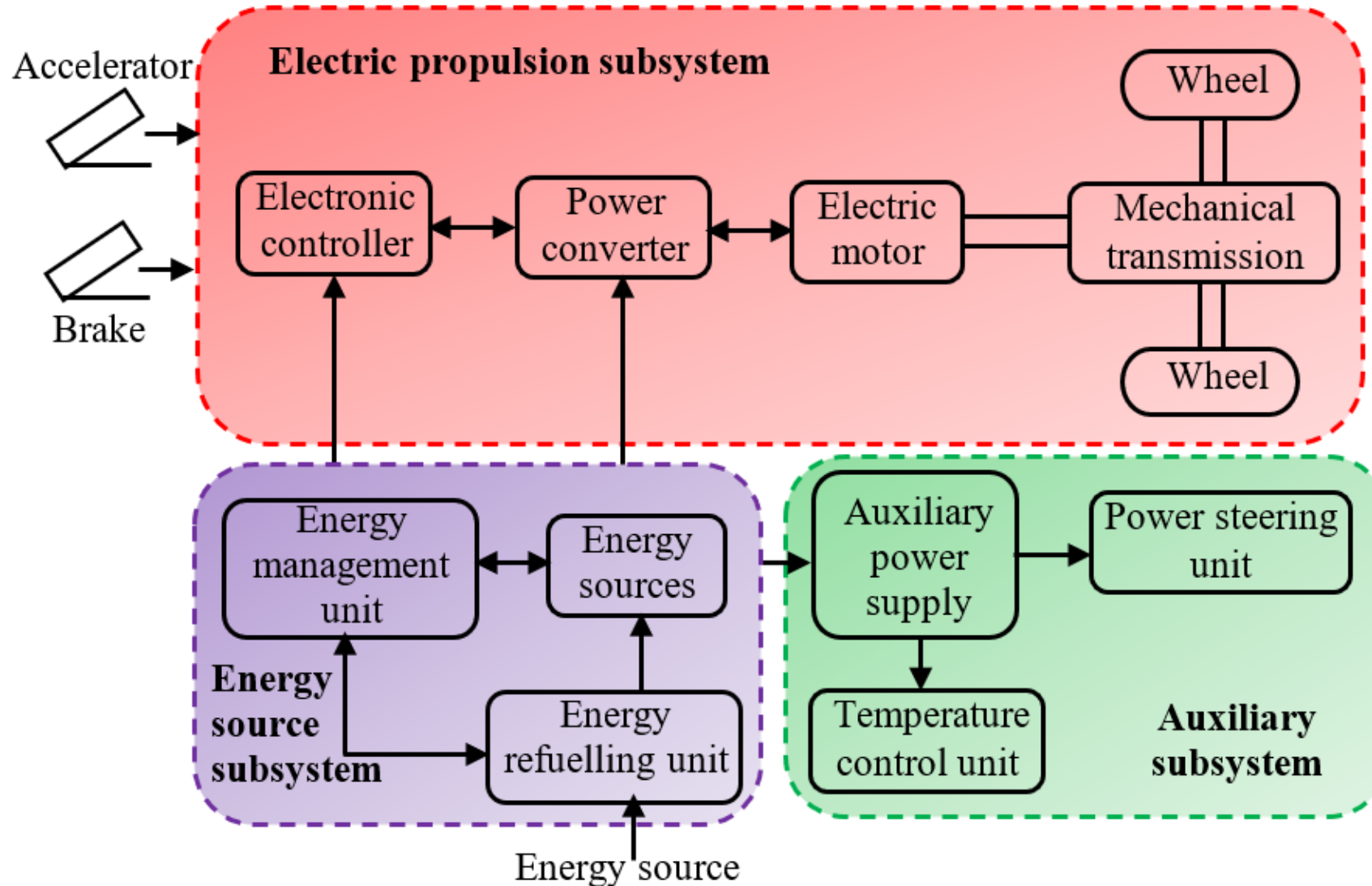

Schematic Layout of EVs and HEVs

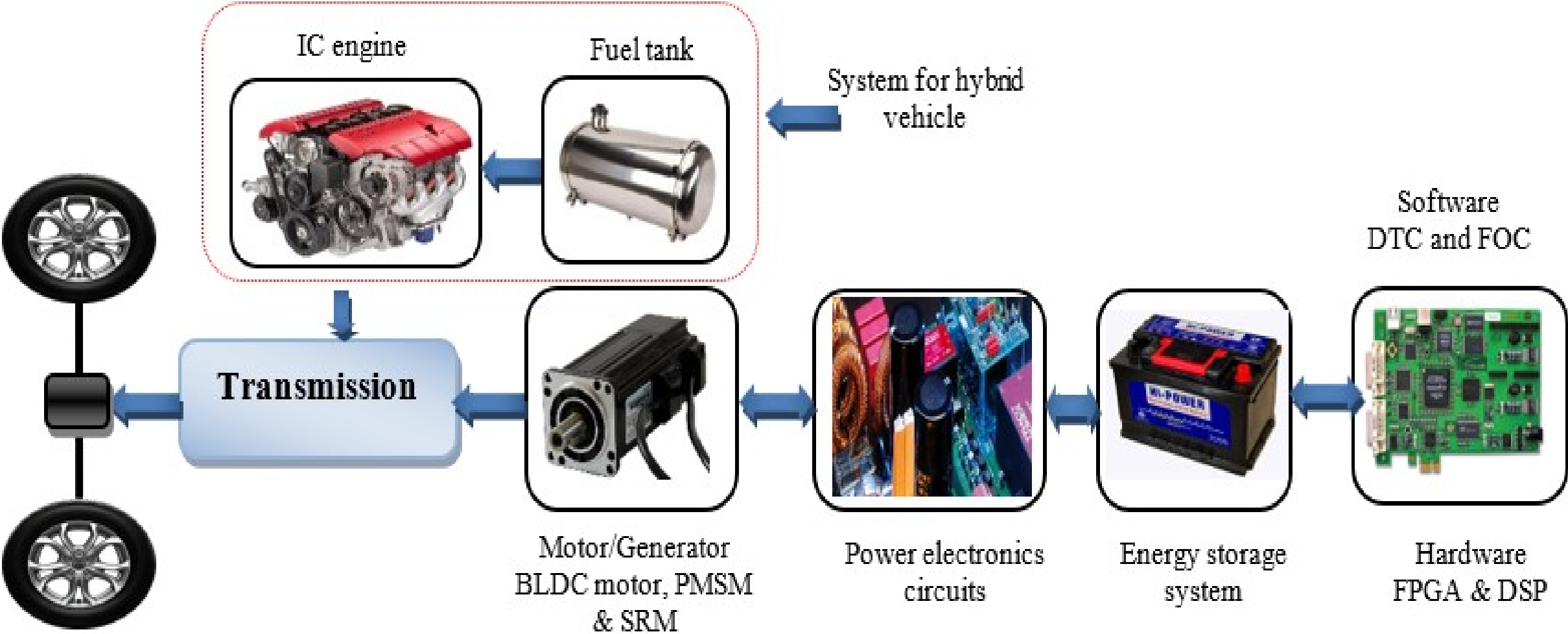

Pictorial View of Electric Vehicles

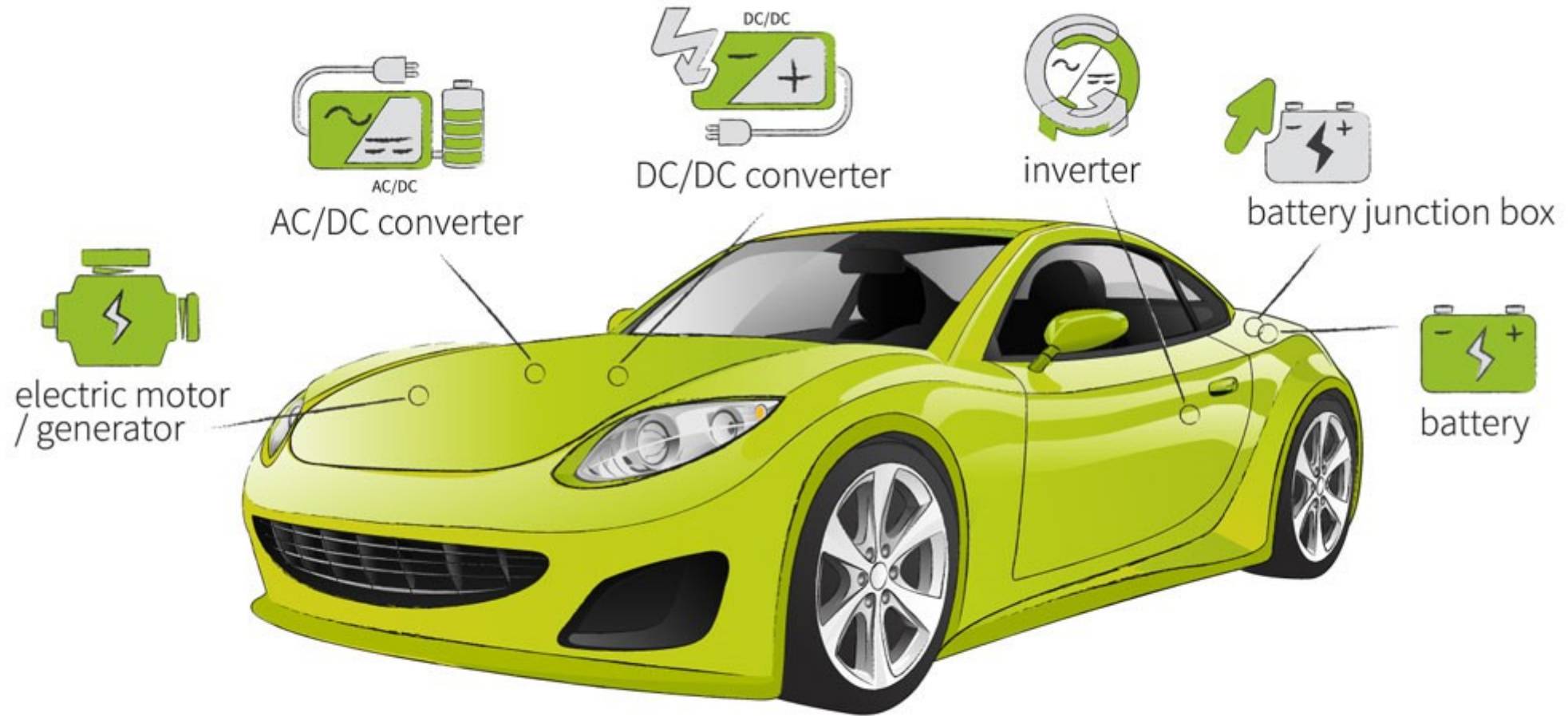

Challenges of Electric Vehicles

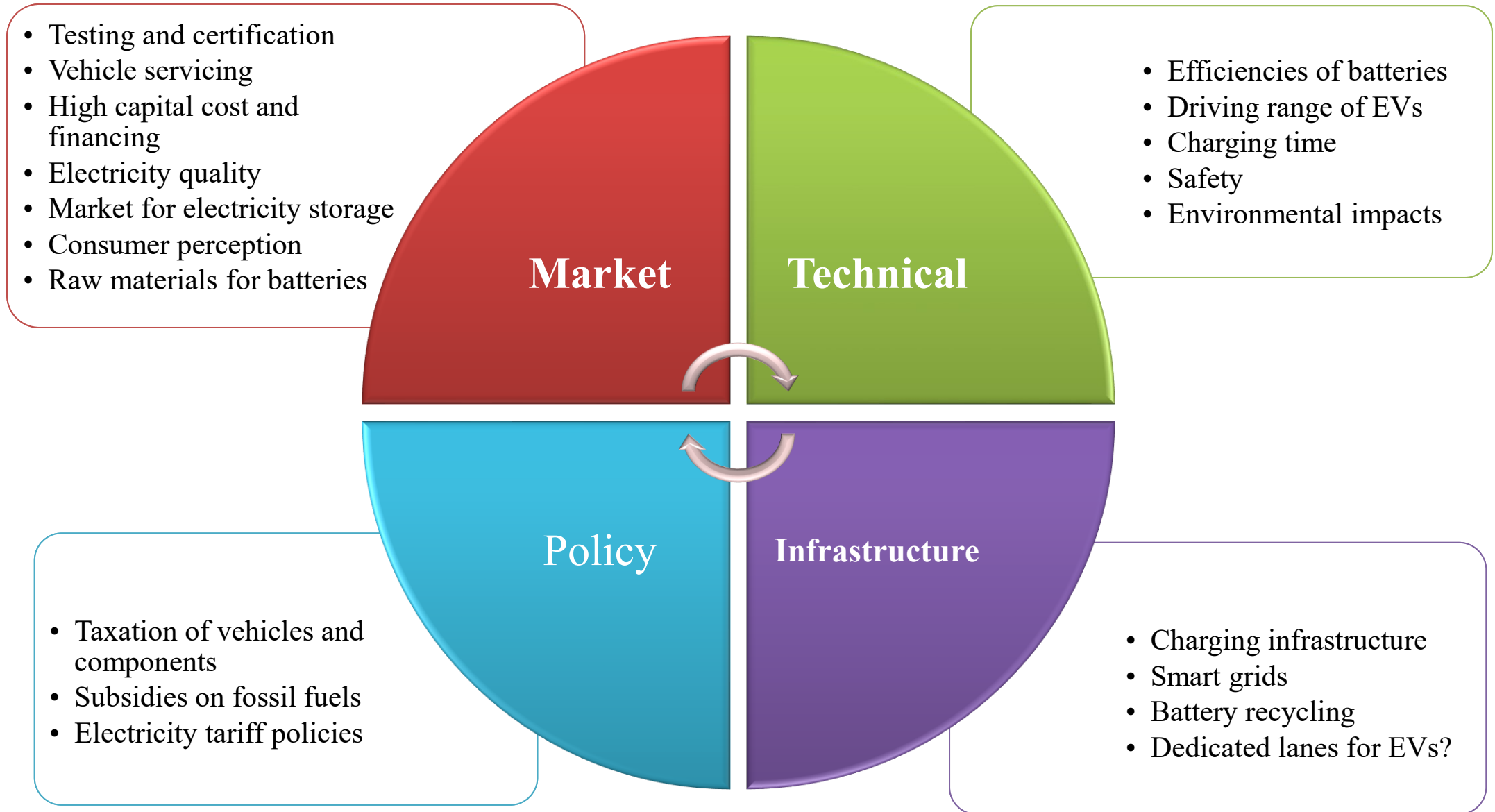

Types of Electric Vehicles [3]

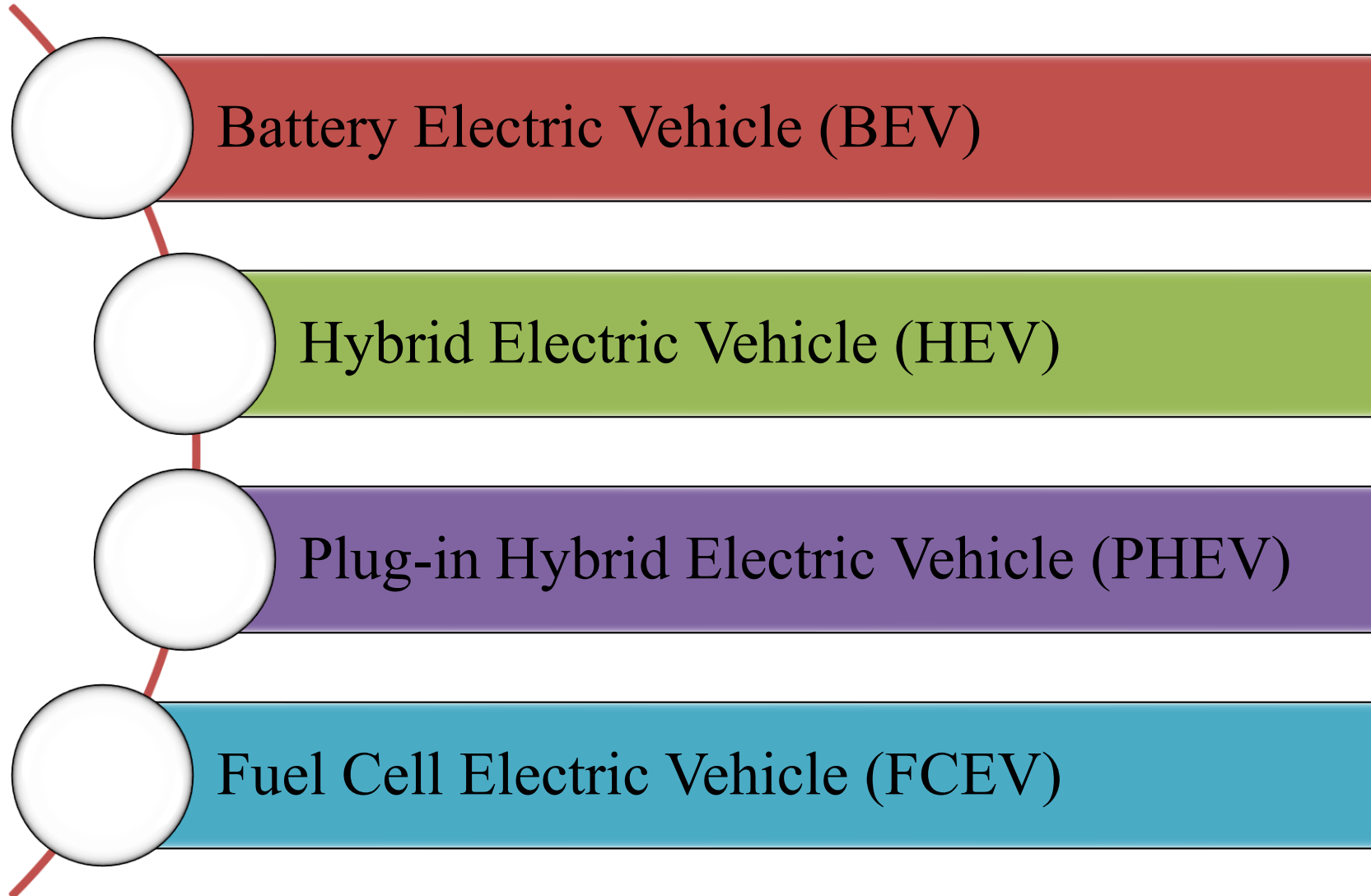

Battery Electric Vehicle (BEV) [3]

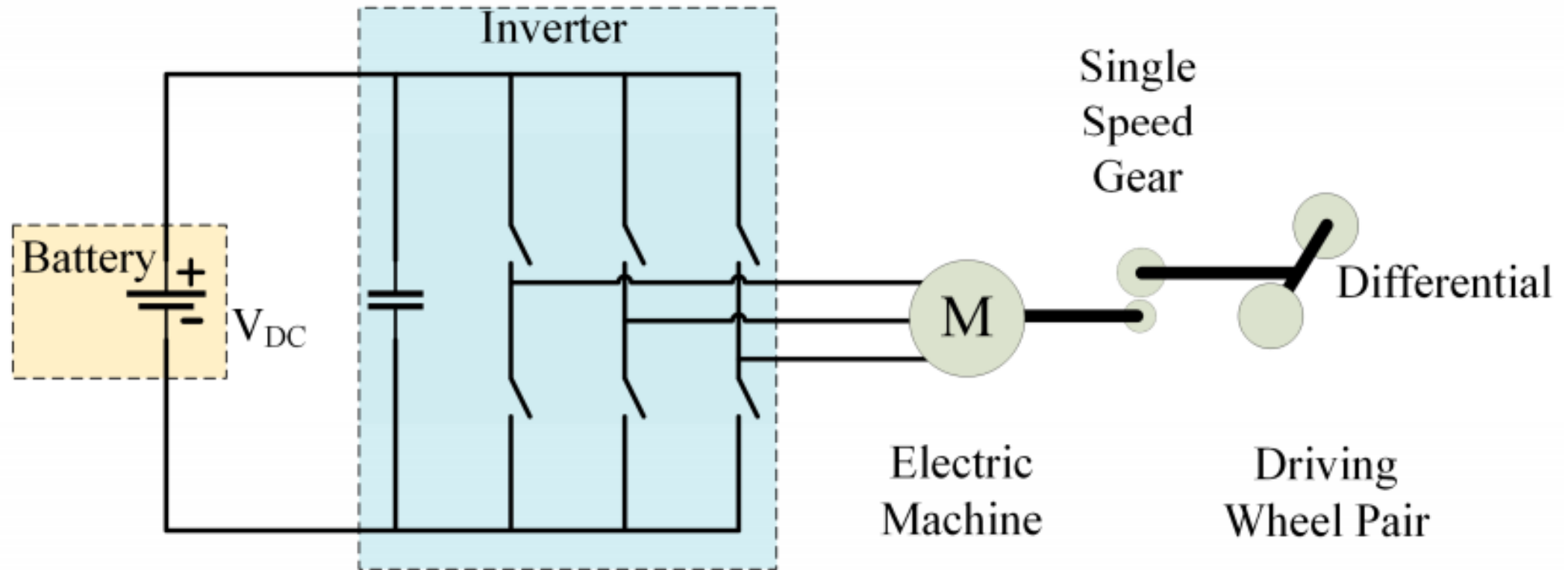

Comparison of Different Type of EVs [3]

EV Type	Driving component	Energy sources	Features	Problems
BEV	Electric motor	<ul style="list-style-type: none"> Battery Ultracapacitor 	<ul style="list-style-type: none"> No emission Not dependent on oil Range depends largely on type of battery used Available commercially 	<ul style="list-style-type: none"> Battery price and capacity Range Charging time Availability of charging stations High price
HEV	<ul style="list-style-type: none"> Electric motor ICE 	<ul style="list-style-type: none"> Battery Ultracapacitor ICE 	<ul style="list-style-type: none"> Very little emission Large range Can get power from both electric and fuel Available commercially 	<ul style="list-style-type: none"> Management of energy sources Battery and engine size optimization
FCEV	Electric motor	<ul style="list-style-type: none"> Fuel cell 	<ul style="list-style-type: none"> Very little emission High efficiency Not dependent on electrical supply High price Available commercially 	<ul style="list-style-type: none"> Cost of fuel cell Feasible way to produce fuel Availability of fuelling facility

Common Battery Used in EVs and HEVs [3]

Lead Acid

Nickel-Metal Hydride (NiMH)

Lithium-Iron (Li-Ion)

Nickel-Zinc (Ni-Zn)

Nickel-Cadmium (Ni-Cd)

Electric Motors for Electric and Hybrid Electric Vehicles

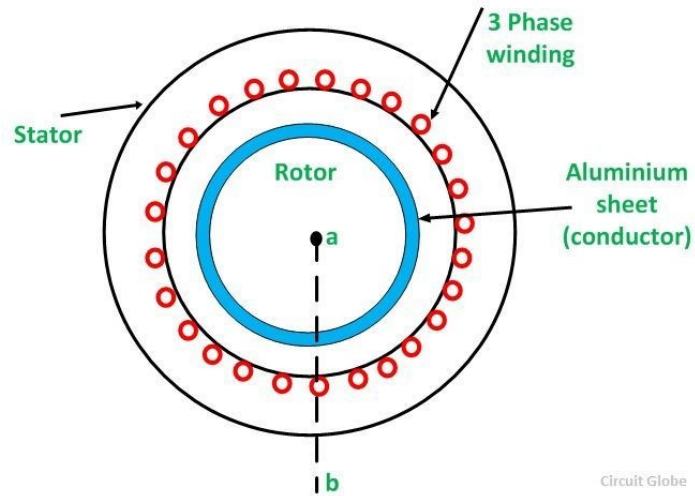

Fig. 1. IM

Stator: Three phase winding
Rotor: Aluminium sheet/Bar

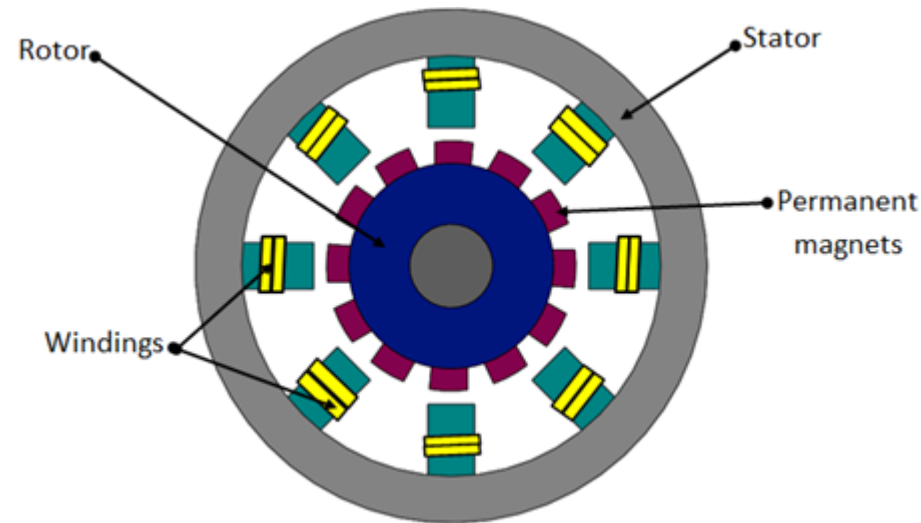

Fig. 2. PMSM/BLDC Motor

Stator: Three phase winding
Rotor: Permanent Magnets

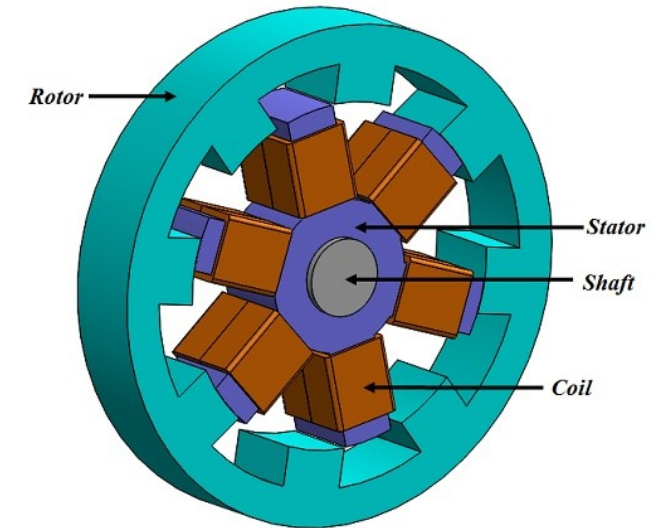

Fig. 3. SRM

Stator: Three phase winding
Rotor: piece of (laminated) steel

Torque Speed Characteristic of IM, PM and SRM

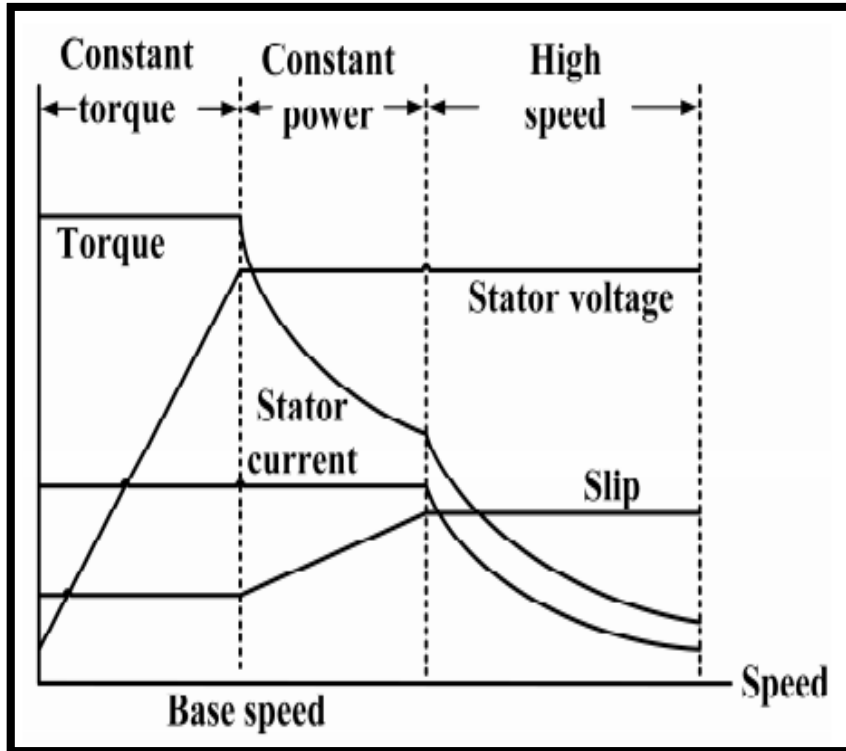

Fig. 4. Induction Motor (IM)

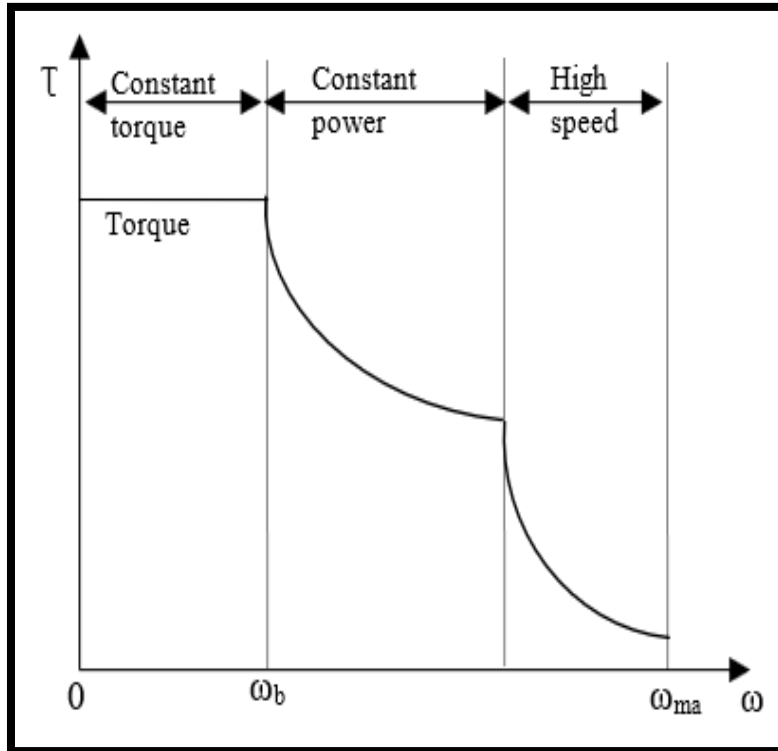

Fig. 5. Permanent Magnet (PM)

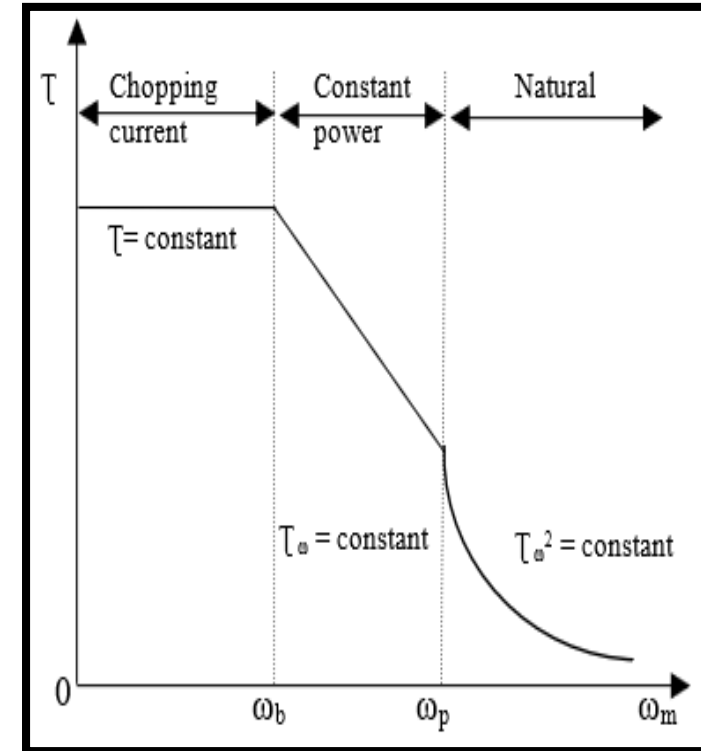
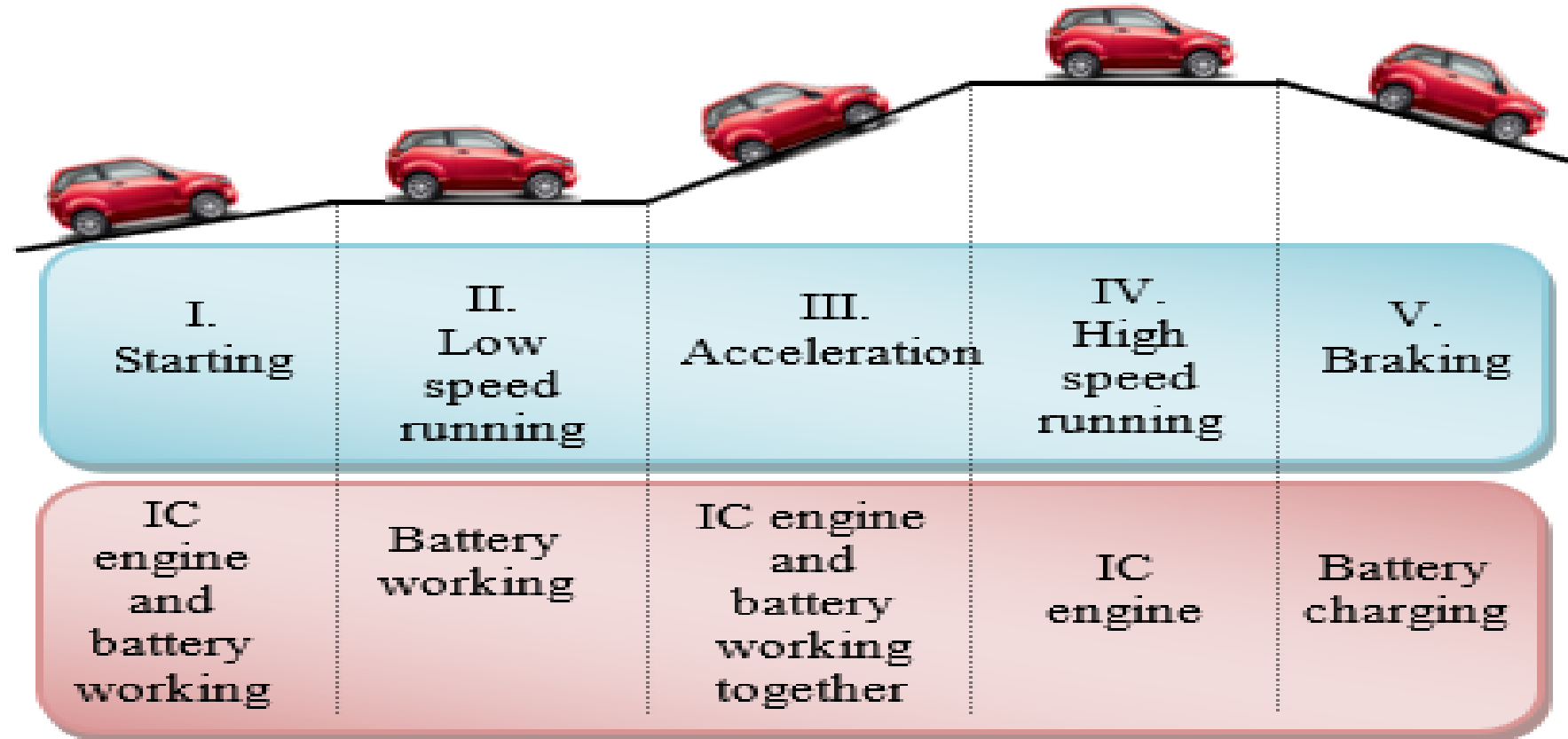

Fig. 6. Switched Reluctance Motor (SRM)

Comparison of Electric Motors [3]

Motor Type	Advantages	Disadvantages	Vehicles Used In
Brushed DC Motor	Maximum torque at low speed	<ul style="list-style-type: none"> • Bulky structure • Low efficiency • Heat generation at brushes 	Fiat panda, Elettra (Series DC motor), Conceptor G-Van (separately excited DC motor)
BLDC Motor	<ul style="list-style-type: none"> • No rotor copper loss • More efficiency than IM • Lighter, Smaller • Better heat dissipation • More torque density and power 	<ul style="list-style-type: none"> • Short constant power range • Decreased torque with increase in speed • High cost because of PM 	Toyota Prius (2005)
PMSM	<ul style="list-style-type: none"> • Operable in different speed ranges without using gear systems • Efficient, Compact • Suitable for in-wheel application • High torque even at very low speeds 	<ul style="list-style-type: none"> ▪ Huge iron loss at high-speed during in-wheel operation 	Toyota Prius, Nissan leaf, Soul EV
IM	<ul style="list-style-type: none"> • The most mature commutator less motor drive system • Can be operated likely a separately excited DC motor by employing field orientation control 	<ul style="list-style-type: none"> ▪ Bulky ▪ More losses 	Tesla Model S, Tesla Model X, Toyota RAV4, GM EVI
SRM	<ul style="list-style-type: none"> • Simple and robust construction • Low cost , High speed • Less chance of hazard, High power density • Long constant power range 	<ul style="list-style-type: none"> • Very noisy • Low efficiency • Larger and heavier than PM machines complex design and control 	Chloride LUCas

Coordination Operation of EVs and HEVs



Typical Placements of Different Power Electronics Converters in an EVs [4]

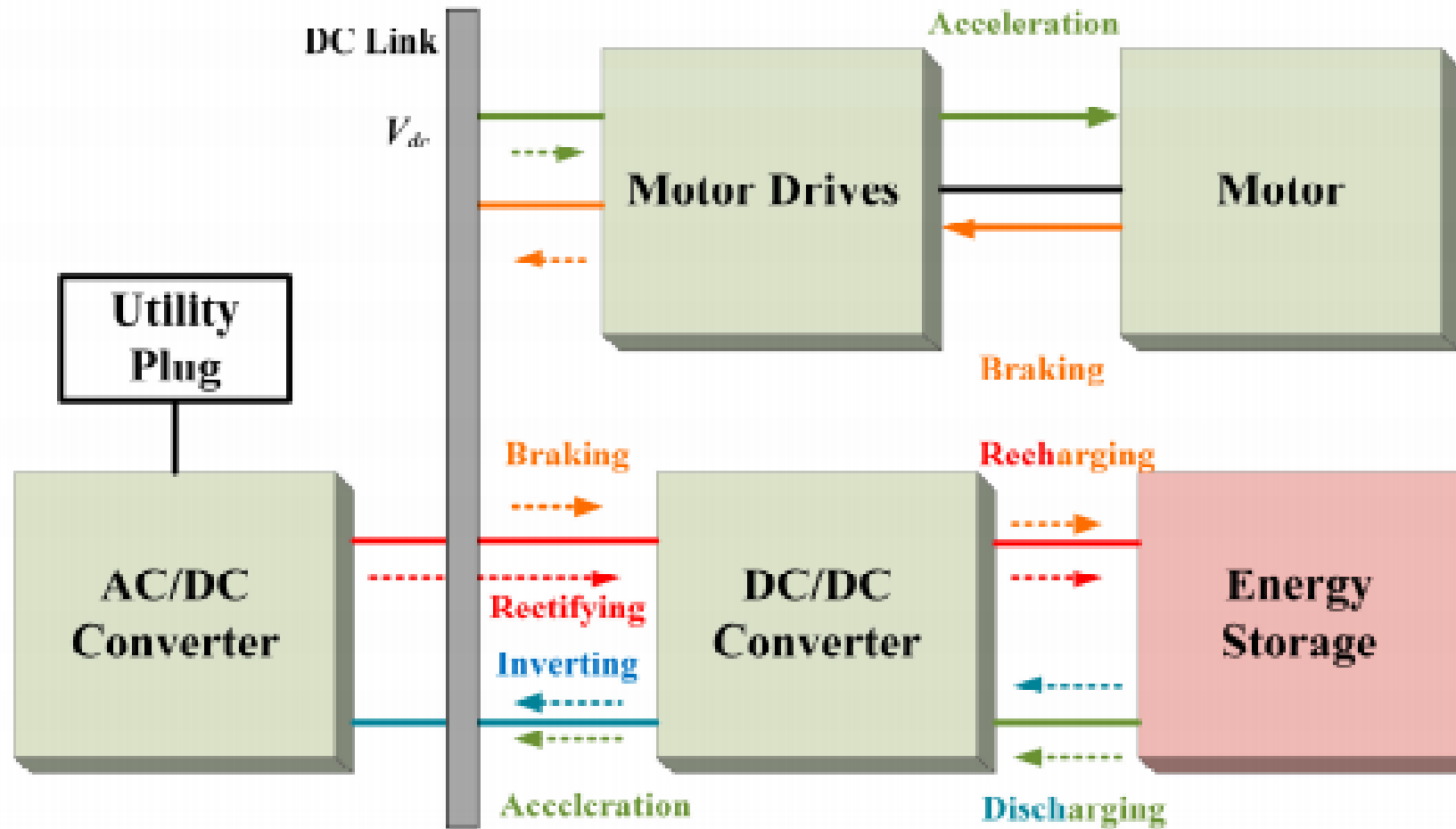

Effects of EVs and HEVs [5]

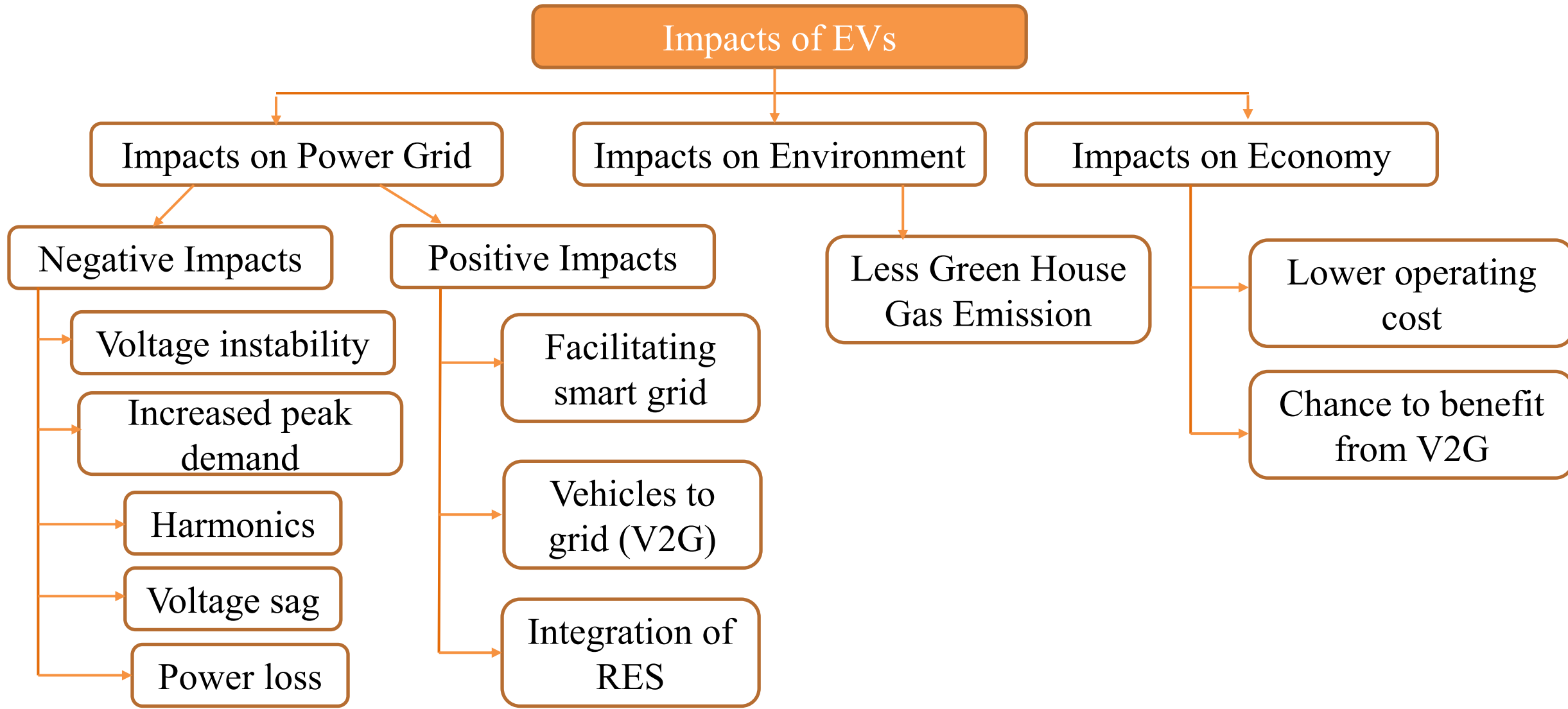

Limitations of EVs [3]

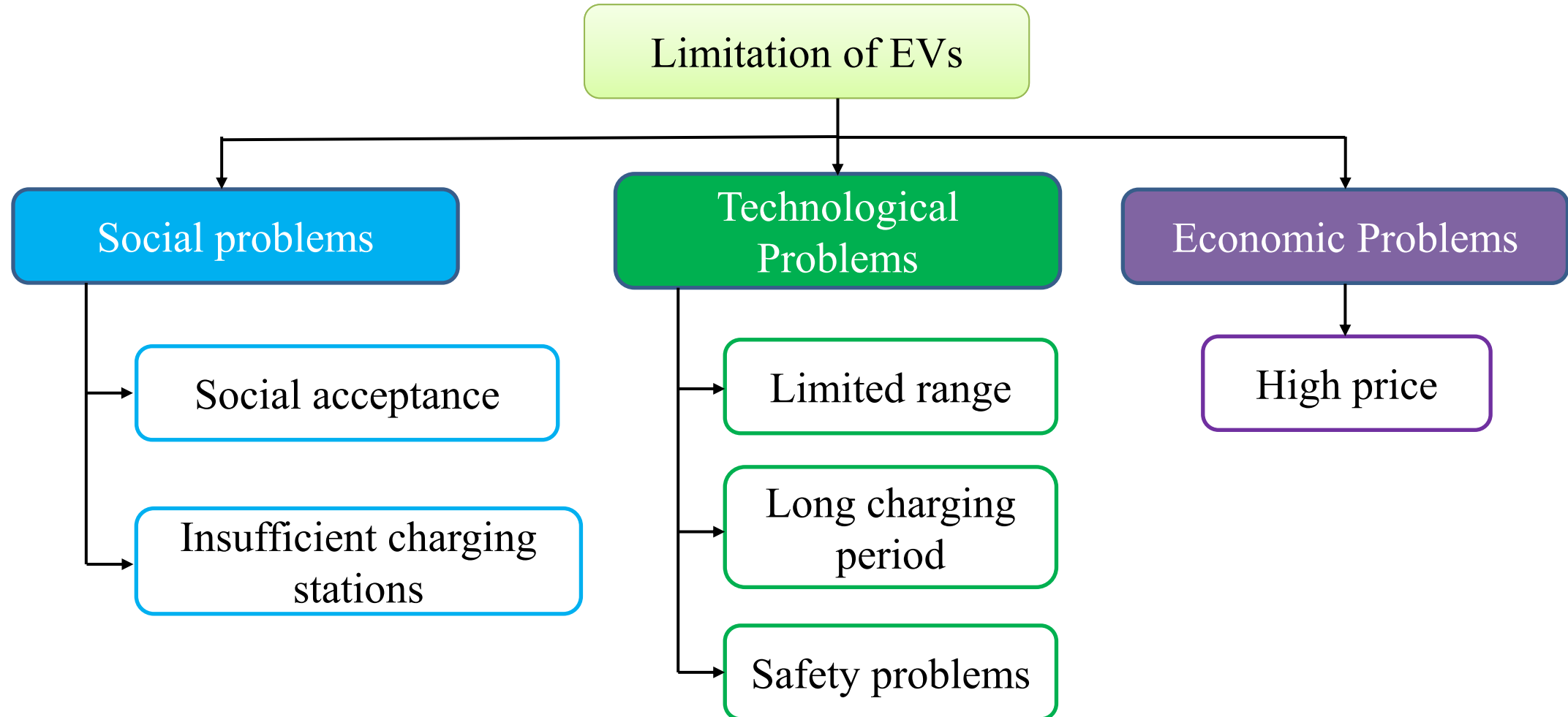

Tentative Solutions of Current Limitations of EVs [3]

Limitation	Probable solution
Limited range	Better energy source and energy management technology
Long charging period	Better charging technology
Safety problems	Advanced manufacturing scheme and build quality
Insufficient charging stations	Placement of sufficient stations capable of providing services to all kinds of vehicles
High price	Mass production, advanced technology, government incentives

Foot Race in Key EVs Factors

Factor	Foot Race
Recharging	Weight of charger, durability, cost, recycling, size, charging time
Hybrid EV	Battery, durability, weight and cost
Hydrogen fuel cell	Cost, hydrogen production, infrastructure, storage, durability and reliability
Auxiliary power unit	Size, cost, weight, durability, safety, reliability, cooling and efficiency

Major Trends and Future Developments

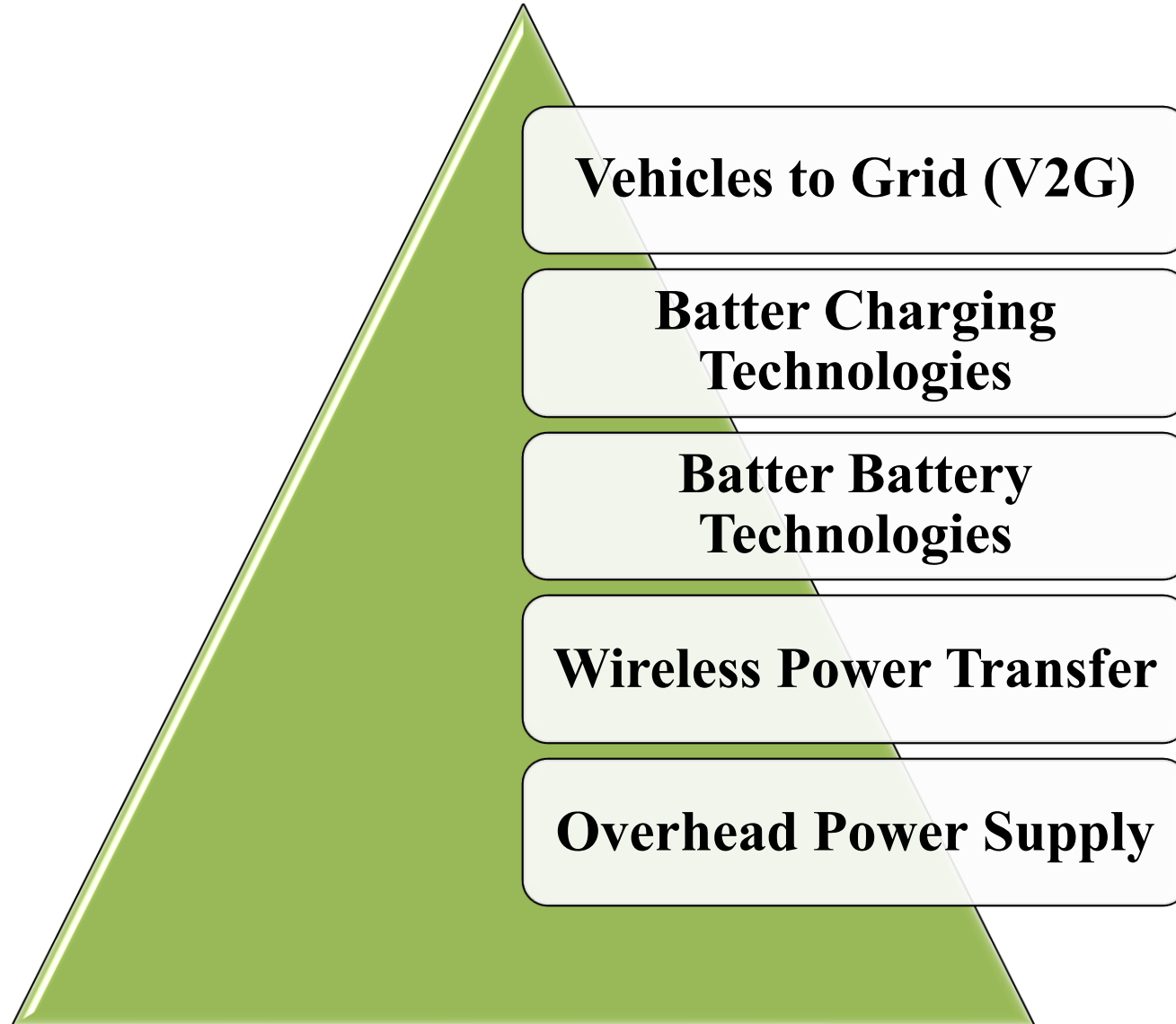

Current Areas of Research

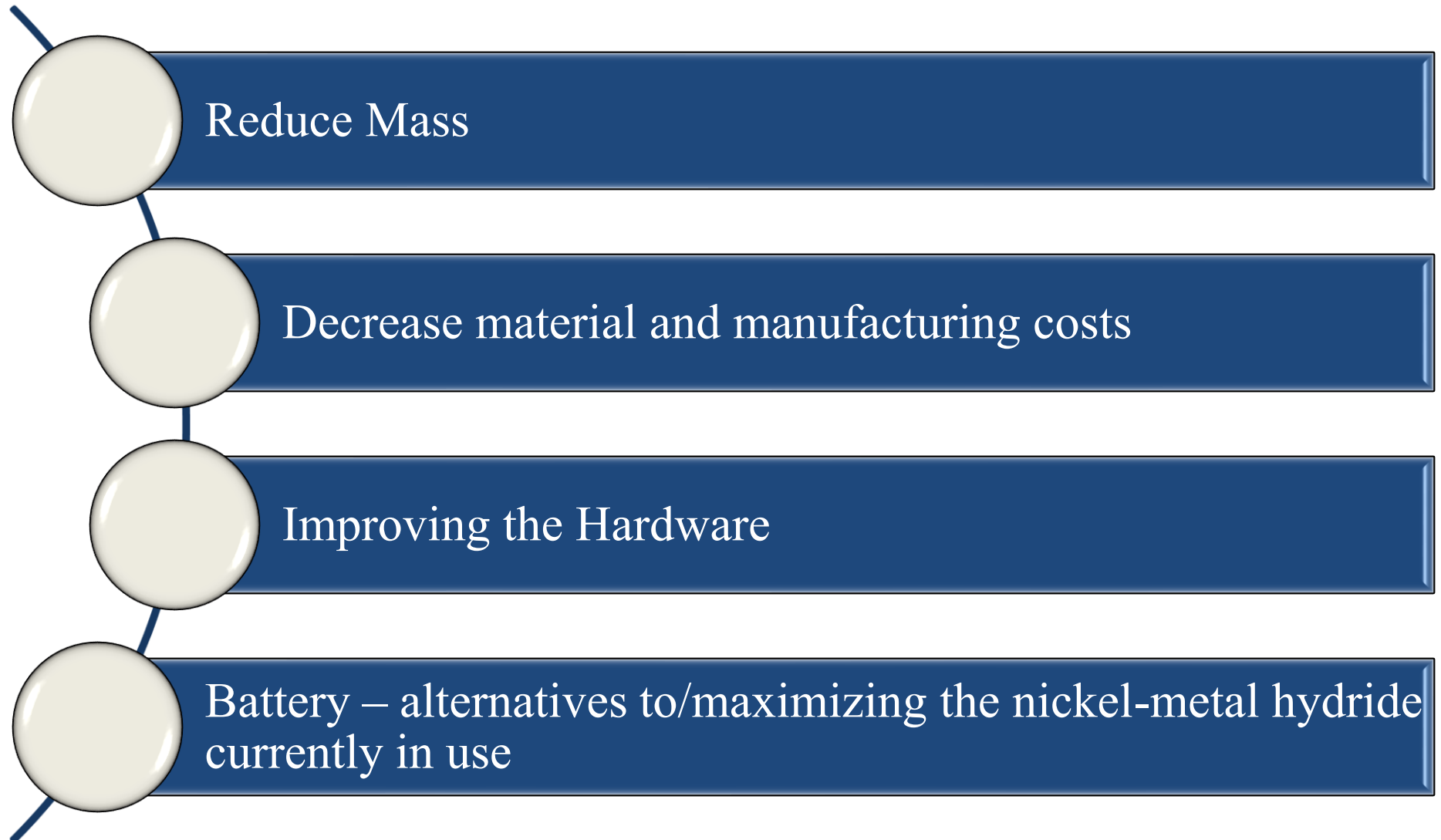

Traction Motors

Electromagnetics

Thermal

Mechanical

NVH

Testing

EV Chargers

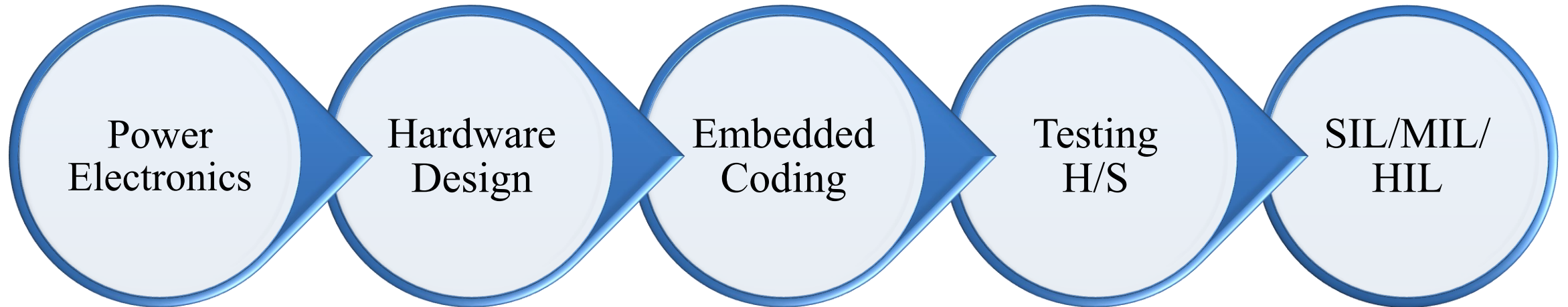

Traction Battery

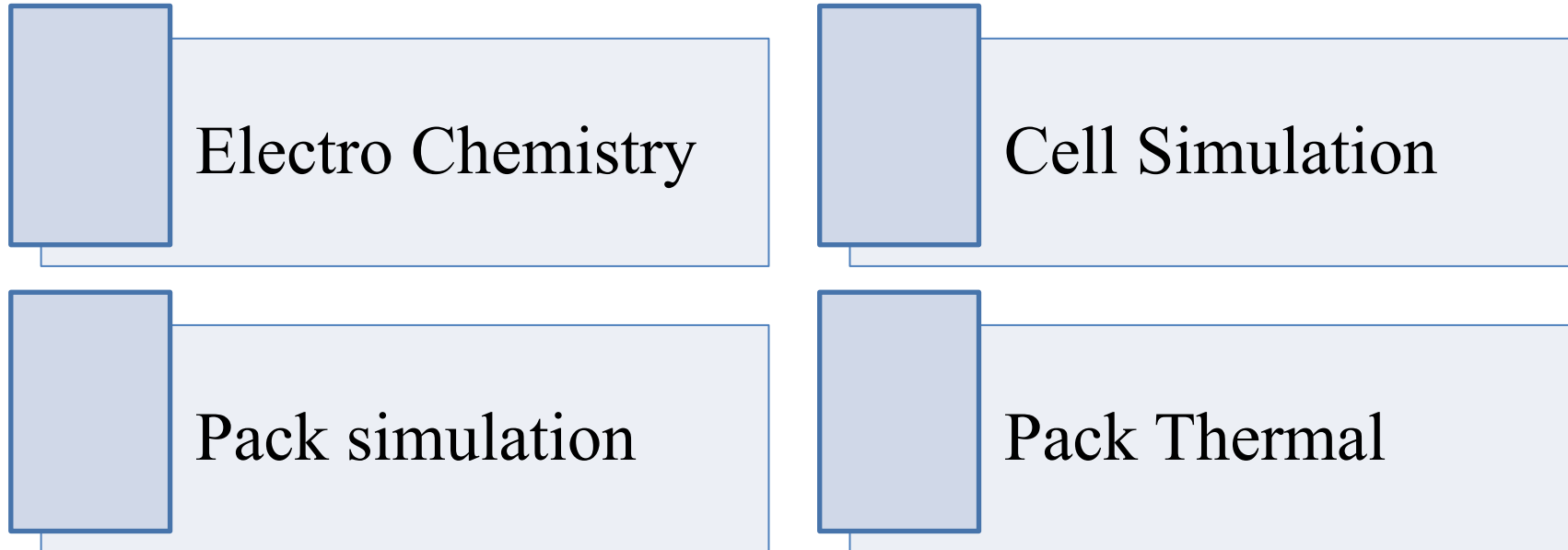

Conclusions

- Discussed about an electrical drives and its applications
- Major components of Electric Vehicles (EVs) and Hybrid Electric Vehicles (HEV)
- Various types of electrical drives and power electronics converter topologies
- Challenges of EVs and HEVs
- Current areas of the research in the EVs and HEVs
- Solutions for challenges

References

1. Global Electrical Vehicles Outlook 2017, International Energy Agency, 2017.
2. C. C. Chan, “The state of the art of electric and hybrid vehicles.” *Proc. IEEE* 2002, 90, 247–275, 2002.
3. F. U. Noor, S. Padmanaban, L. M. Popa, M. N. Mollah and E. Hossain, “A Comprehensive Study of Key Electric Vehicle (EV) Components, Technologies, Challenges, Impacts, and Future Direction of Development,” *Energies* 2017, 10, 1217, pp. 1-84, 2017.
4. A. M. Lulhe, T. N. Date, “A technology review paper for drives used in EV and HEV,” In Proceedings of the 2015 International Conference on Control, Instrumentation, ICCICCT, Kumaracoil, India, 18–19 Dec. 2015
5. Grunditz, E.A. Thiringer, T. “Performance Analysis of Current BEVs Based on a Comprehensive Review of Specifications,” *IEEE Trans. Transp. Electr.* 2016, 2, 270–289.

Thank you for your attention
Queries



The future really is in our hands!